



USE AND MAINTENANCE MANUAL

TRANSLATION OF THE ORIGINAL INSTRUCTIONS – ENGLISH

MAGIC WELD 200

- Motosaldatrice
- Engine Driven Welder
- Motosoudeuse
- Motosoldadoras
- Schweißaggregat
- Motosoldadora
- По Вышкам

Codice
Code
Code
Codigo
Kodezahl
Código
Код

222509003

Edizione
Edition
Édition
Edición
Ausgabe
Edição
Издание

01.2016



MADE IN ITALY

MOSA Weld

The engine driven welder is arranged as a single block composed of the engine and stainless steel box structure where the front is the cover. All electrical components of the machine (except for the reactor which is located on the base under the engine) are located inside, which are: an alternator with permanent magnets, a high frequency chopper bridge, a control board for the welding current, an inverter which generates alternating current of 50Hz with 230 or 110 volts and an electromagnet for the tick-over.

Main features:

- D.C. welding current 200A at 60%
- Continuous regulation of the welding current with "Chopper System"
- Suitable for basic and rutile electrodes. A reactance for cellulose electrodes is available as an option
- Antistick function (small arc force)
- Continuous auxiliary output 50Hz to 230V/3kVA to 110V/2kVA (50 Hz/60Hz)
- Engine accelerator at minimum/maximum at load take up
- Weight 61 Kg
- Acoustic Power 74 dBA to 7m

Electrical components of the machine:

Regulation knob for welding current

Remote control socket

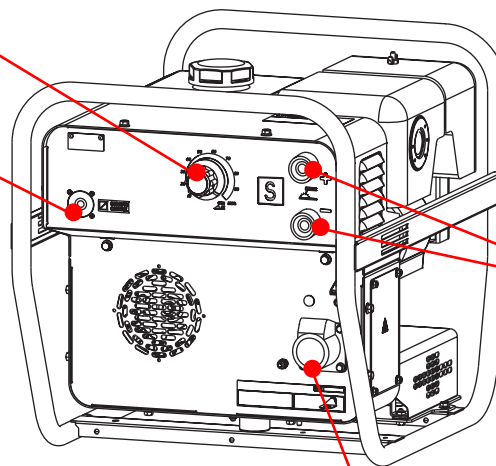

Welding sockets

Auxiliary output

- Permanent magnet alternator: the alternator has 2 galvanically separated windings, one for welding and the other for the auxiliary output.
- Tick-over solenoid: an electromagnet in absence of load. When the load is present, welding or auxiliary output, the electromagnet is not supplied any more and the engine speed goes to the maximum (4000 rpm rated open circuit).
- High frequency chopper diode bridge: it regulates the welding current using the "Chopper System", which chops the welding D.C. current at high frequency.
- Hall sensor: it measures with high precision the welding current and it's completely isolated from the welding circuit.
- Serie's reactance
- Welding current adjustment board: a board controls the welding process and supplies the engine accelerator control electromagnet.
- Auxiliary in alternating current. An inverter generates alternating current 110/230V 50Hz with continuous current (duty cycle 100%) of 1.8 kVA/ 2.5 kVA

M 1.01	COPYRIGHT
M 1.1	NOTES
M 1.4	CE MARK
M 1.5	TECHNICAL DATA
M 2	ADVICE
M 2.1	SYMBOLS
M 2.2	ADVICE ENGINE DRIVEN WELDER
M 2.6	INSTALLATION AND ADVICE
M 2.7	INSTALLATION AND DIMENSIONS
M 3	UNPACKING AND TRANSPORT
M 6.15	ASSEMBLING: CTM - MW 200
M 25	SET-UP FOR OPERATION
M 26	ENGINE STARTING
M 27	STOPPING THE ENGINE
M 31	CONTROLS
M 34...	USE AS A WELDER
M 34.2	CHECKING AN ADJUST THE MAXIMUM WELDING CURRENT
M 34.3	PARALLEL ENGINE DRIVEN WELDER
M 37	USE AS A GENERATOR
M 40.2...	TROUBLE-SHOOTING
M 43	MAINTENANCE
M 45	STORAGE - CUST OFF
M 55	RECOMMENDED ELECTRODES
M 60	ELECTRICAL SYSTEM LEGENDE
M 61-.....	ELECTRICAL SYSTEM



ATTENTION

This use and maintenance manual is an important part of the machines in question.

The assistance and maintenance personnel must keep said manual at disposal, as well as that for the engine and alternator (if the machine is synchronous) and all other documentation about the machine.

We advise you to pay attention to the pages concerning the security (see page M1.1).



© All rights are reserved to said Company.

It is a property logo of MOSA division of B.C.S. S.p.A. All other possible logos contained in the documentation are registered by the respective owners.

👉 The reproduction and total or partial use, in any form and/or with any means, of the documentation is allowed to nobody without a written permission by MOSA division of B.C.S. S.p.A.

To this aim is reminded the protection of the author's right and the rights connected to the creation and design for communication, as provided by the laws in force in the matter.

In no case MOSA division of B.C.S. S.p.A. will be held responsible for any damage, direct or indirect, in relation with the use of the given information.

MOSA division of B.C.S. S.p.A. does not take any responsibility about the shown information on firms or individuals, but keeps the right to refuse services or information publication which it judges discutible, unright or illegal.

INFORMATION

Dear Customer,
We wish to thank you for having bought a high quality set.

Our sections for Technical Service and Spare Parts will work at best to help you if it were necessary.

To this purpose we advise you, for all control and overhaul operations, to turn to the nearest authorized Service Centre, where you will obtain a prompt and specialized intervention.

☞ In case you do not profit on these Services and some parts are replaced, please ask and be sure that are used exclusively original parts; this to guarantee that the performances and the initial safety prescribed by the norms in force are re-established.

☞ *The use of **non original spare parts will cancel immediately any guarantee and Technical Service obligation.***

NOTES ABOUT THE MANUAL

Before actioning the machine please read this manual attentively. Follow the instructions contained in it, in this way you will avoid inconveniences due to negligence, mistakes or incorrect maintenance. The manual is for qualified personnel, who knows the rules: about safety and health, installation and use of sets movable as well as fixed.

You must remember that, in case you have difficulties for use or installation or others, our Technical Service is always at your disposal for explanations or interventions.

The manual for Use Maintenance and Spare Parts is an integrant part of the product. It must be kept with care during all the life of the product.

In case the machine and/or the set should be yielded to another user, this manual must also given to him.

Do not damage it, do not take parts away, do not tear pages and keep it in places protected from dampness and heat.

You must take into account that some figures contained in it want only to identify the described parts and therefore might not correspond to the machine in your possession.

INFORMATION OF GENERAL TYPE

In the envelope given together with the machine and/or set you will find: the manual for Use Maintenance and Spare Parts, the manual for use of the engine and the tools (if included in the equipment), the guarantee (in the countries where it is prescribed by law).

The Manufacturer shall not be liable for ANY USE OF THE PRODUCT OTHER THAN THAT PRECISELY SPECIFIED IN THIS MANUAL and is thus not liable for any risks which may occur as a result of IMPROPER USE. The Company does not assume any liability for any damage to persons, animals or property.

Our products are made in conformity with the safety norms in force, for which it is advisable to use all these devices or information so that the use does not bring damage to persons or things.

While working it is advisable to keep to the personal safety norms in force in the countries to which the product is destined (clothing, work tools, etc.).

Do not modify for any motive parts of the machine (fastenings, holes, electric or mechanical devices, others..) if not duly authorized in writing: the responsibility coming from any potential intervention will fall on the executioner as in fact he becomes maker of the machine.

☞ **Notice:** *the manufacturer, who keeps the faculty, apart the essential characteristics of the model here described and illustrated, to bring betterments and modifications to parts and accessories, without putting this manual uptodate immediately.*



Any of our product is labelled with CE marking attesting its conformity to applicable directives and also the fulfillment of safety requirements of the product itself; the list of these directives is part of the declaration of conformity included in any machine standard equipment.

Here below the adopted symbol:



CE marking is clearly readable and unerasable and it can be either part of the data-plate.

	Made in UE-ITALY	TYPE	
	SERIAL N°		
	X		
	I ₂ (A)		
	U ₀	U ₂ (V)	
	I ₂ (A)		
	U ₀	U ₂ (V)	
	Hz	kVA	
	P.F.	V (V)	
		I (A)	
	n	RPM	n ₁
	n ₀	RPM	P _{1max}
		IP	
		KW	I. CL.

	Made in UE-ITALY	TYPE	
	Generating Set ISO 8528	SERIAL N°	
	KVA		
	V		
	I		
	Hz	P.F.	LTP POWER IN ACCORDANCE WITH ISO 8528
	RPM	I. CL.	IP
	ALTIT. 100 m	TEMP. 25 °C	MASS

	TYPE	
	SERIAL N°	Made in UE-ITALY
	TYPE/N°	
	VOLTAGE(V)	
	POWER(W)	
	Hz	KVA
	P.F.	V(V)
	I.C.L.	I(A)
	LTP POWER IN ACCORDANCE WITH ISO 8528	
	n	RPM
	P _{max}	TEMP. °C
		ALTIT. m
		IP
		Kg

	Made in UE-ITALY	I. CL.	
	IEC 60974-1	IP	
	U ₀		
	X	I ₂	U ₂
	n	RPM	n ₁
	n ₀	RPM	P _{1max}
		RPM	kw
	P	V	I

Furthermore, on each model it is shown the noise level value; the symbol used is the following:

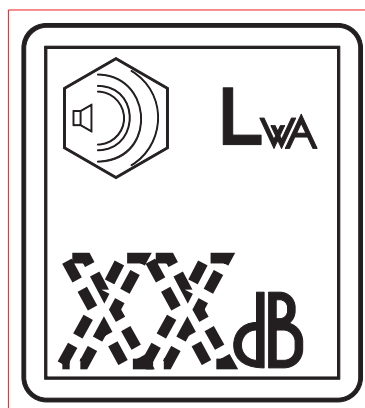

The indication is shown in a clear, readable and indeleble way on a sticker.



Technical data

MAGIC WELD 200

D.C. WELDING

Current range, continuous	20 - 200A
Open circuit voltage	70V
Duty cycle	200 A - 60%

A.C. GENERATION

230 V

110 V

Single-phase output (max)	3 kVA / 230 V / 13 A	2 kVA / 110 V / 18.2A - 50 Hz / 60 Hz
Single-phase output (continuous)	2.5 kVA/ 230 V /10.9 A	1.8 kVA / 110 V / 16.4 A - 50 Hz / 60 Hz
Cos φ	0.8	0.8

ALTERNATOR

Self-excited, brushless

Type	permanent magnet
Insulating class	H

ENGINE

Mark / Model	HONDA / GX 270
Type / Cooling system	Gasoline 4-stroke OHV / Air
Cylinders / Displacement	1 / 270 cm ³
Output max	6.3 kW (8.5 HP)
Speed	3600 rpm
Fuel consumption (Welding 60%)	1.5 l/h
Engine oil capacity	1.1 l
Starter	recoil

GENERAL SPECIFICATIONS

Tank capacity	5.3 l
Running time (Welding 60%)	3.5 h
Protection	IP 23
Dimensions max. on base LxIxh *	630x490x540
Weight (dry) *	61 Kg
Acoustic power LwA (pressure LpA)	99 dB(A) (74 dB(A) @ 7 m)

* Dimensions and weight are inclusive of all parts.

POWER

Declared power according to ISO 3046-1 (temperature 25°C, 30% relative humidity, altitude 100 m above sea level).

It's admitted overload of 10% each hour every 12 h.

In an **approximative** way one reduces: of 1% every 100 m altitude and of 2.5% for every 5°C above 25°C.

ACOUSTIC POWER LEVEL

ATTENTION: The concrete risk due to the machine depends on the conditions in which it is used. Therefore, it is up to the end-user and under his direct responsibility to make a correct evaluation of the same risk and to adopt specific precautions (for instance, adopting a I.P.D. -Individual Protection Device)

Acoustic Noise Level (L_{WA}) - Measure Unit dB(A): it stands for acoustic noise released in a certain delay of time. This is not submitted to the distance of measurement.

Acoustic Pressure (L_p) - Measure Unit dB(A): it measures the pressure originated by sound waves emission. Its value changes in proportion to the distance of measurement.

The here below table shows examples of acoustic pressure (L_p) at different distances from a machine with Acoustic Noise Level (L_{WA}) of 95 dB(A)

Lp a 1 meter = 95 dB(A) - 8 dB(A) = 87 dB(A)

Lp a 7 meters = 95 dB(A) - 25 dB(A) = 70 dB(A)

Lp a 4 meters = 95 dB(A) - 20 dB(A) = 75 dB(A)

Lp a 10 meters = 95 dB(A) - 28 dB(A) = 67 dB(A)

PLEASE NOTE: the symbol  when with acoustic noise values, indicates that the device respects noise emission limits according to 2000/14/CE directive.

 The installation and the general advice concerning the operations, are finalized to the correct use of the machine, in the place where it is used as generator group and/or welder.

- Advice to the User about the safety:

 **N.B.:** The information contained in the manual can be changed without notice. Potential damages caused in relation to the use of these instructions will not be considered because these are only indicative. Remember that the non observance of the indications reported by us might cause damage to persons or things. It is understood, that local dispositions and/or laws must be respected.

 **DANGEROUS**

This heading warns of an immediate danger for persons as well for things. Not following the advice can result in serious injury or death.

 **WARNING**

This heading warns of situations which could result in injury for persons or damage to things.

 **CAUTION**



To this advice can appear a danger for persons as well as for things, for which can appear situations bringing material damage to things.

 **IMPORTANT**



 **NOTE**

These headings refer to information which will assist you in the correct use of the machine and/or accessories.

 **ATTENTION**

  **FIRST AID.** In case the operator should be sprayed by accident, from corrosive liquids a/o hot toxic gas or whatever event which may cause serious injuries or death, predispose the first aid in accordance with the ruling labour accident standards or of local instructions.

Skin contact	Wash with water and soap
Eyes contact	Irrigate with plenty of water, if the irritation persists contact a specialist
Ingestion	Do not induce vomit as to avoid the intake of vomit into the lungs, send for a doctor
Suction of liquids from lungs	If you suppose that vomit has entered the lungs (as in case of spontaneous vomit) take the subject to the hospital with the utmost urgency
Inhalation	In case of exposure to high concentration of vapours take immediately to a non polluted zone the person involved

  **FIRE PREVENTION.** In case the working zone, for whatsoever cause goes on fire with flames liable to cause severe wounds or death, follow the first aid as described by the ruling norms or local ones.

EXTINCTION MEANS	
Appropriated	Carbonate anhydride (or carbon dioxide) powder, foam, nebulized water
Not to be used	Avoid the use of water jets
Other indications	Cover eventual shedding not on fire with foam or sand, use water jets to cool off the surfaces close to the fire
Particular protection	Wear an autorespiratory mask when heavy smoke is present
Useful warnings	Avoid, by appropriate means to have oil sprays over metallic hot surfaces or over electric contacts (switches, plugs, etc.). In case of oil sprinkling from pressure circuits, keep in mind that the inflammability point is very low.

SYMBOLS IN THIS MANUAL

- The symbols used in this manual are designed to call your attention to important aspects of the operation of the machine as well as potential hazards and dangers for persons and things.

This symbol is used to draw your attention to the fact that the welder is being used correctly and that the machine or equipment used operates perfectly.



STOP - Read absolutely and be duly attentive



HIGH VOLTAGE - Attention High Voltage. There can be parts in voltage, dangerous to touch. The non observance of the advice implies life danger.



FIRE - Danger of flame or fire. If the advice is not respected fires can happen.



HEAT - Hot surfaces. If the advice is not respected burns or damage to things can be caused.



EXPLOSION - Explosive material or danger of explosion. in general. If the advice is not respected there can be explosions.



WATER - Danger of shortcircuit. If the advice is not respected fires or damage to persons can be caused.



SMOKING - The cigarette can cause fire or explosion. If the advice is not respected fires or explosions can be caused.



WRENCH - Use of the tools. If the advice is not respected damage can be caused to things and even to persons.



ACCES FORBIDDEN to non authorized people.

Use only with safety clothing -



It is compulsory to use the personal protection means given in equipment.

Use with safe materials only -



Never use water to put out fires on electrical equipment

Use only with non inserted voltage -



It is prohibited to make interventions before having disinserted the voltage.

No smoking -



It is prohibited to smoke while filling the tank with fuel.

Do not refuel -



Do not refuel when the engine is hot.



Switch off the engine prior to refuelling.

Fire -



Fuel can cause fires.

Use only with safety protections -



It is advisable to use all protections while shifting the machine.

Use only with safety protections -



It is advisable to use protections suitable for the different daily checking works and/or of maintenance.

Exhaust gases -



Exhaust gases from the engine can kill.

Petrol vapours -















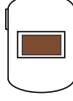

Petrol vapours cause fires and can seriously damage your health.

Moving parts -











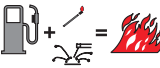

Moving parts are dangerous. Avoid touching any moving parts with your hands or fingers. Never wear loose clothing which may get trapped by moving parts.

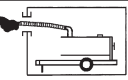
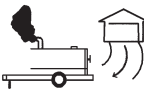
ARC WELDING HAZARDS

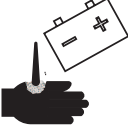
	<p>Electric shock from welding electrode or wiring can kill.</p>		<p>Welding sparks can cause fires. Have a fire extinguisher nearby, and have a trained fire watcher ready to use it.</p>
	<p>Wear dry, hole-free insulating gloves and body protection. Do not touch electrode with bare hand. Do not wear wet or damaged gloves. Do not touch live electrical parts. Wet or confined spaces, or if their is una danger of falling. Use AC output ONLY if required for the welding process. If AC output is required, use remote output control if present on unit.</p>		<p>Arc rays can burn eyes and skin.</p>
	<p>Magnetic fields can affect pace-makers. Pace-maker wearers keep away from arc welding and cutting operations and equipment. Wearers should consult their doctor before going near arc welding, gouging, arc cutting, or spot welding operations.</p>		<p>Use welding helmet with correct shade of filter.</p>
	<p>Protect yourself from electric shock by insulating yourself from work and ground. Use non-flammable, dry insulating material if possible, or use dry rubber amts, dry wood or plywood, or other dry insulating material big enough to cover your full area of contract with the work or ground, and watch for fire.</p>		<p>Wear welders cap and safety glasses with side shields. Use ear protection when welding out of position or in confined spaces. Button shirt collar.</p>
	<p>Breathing welding fumes can be hazardous to your health.</p>		<p>Wear complete body protection. Wear oil free protective clothing such as leather gloves, heavy shirt, cuffless pants, and hight boots.</p>
	<p>Keep your out of the fumes. Do not breathe the fumes. Use enough ventilation, exhaust at the arc, or both, to keep fumes and gases from your breathing zone and the general area.</p>		<p>Use enough forced ventilation or local exhaust (forced suction) at the arc to remove the fumes from your breathing area.</p>
	<p>Use a ventilating fan to remove fumes from the breathing zone and welding area. If adequancy of ventilation or exhaust is uncertain, have the air quality checked.</p>		<p>Welding can cause fire or explosion.</p>
	<p>Do not weld near flammable material. Move flammanles at least (10 m) away or protect them with flame-proof covers.</p>		<p>Do not weld on drums, tanks, or any closed containers unless a qualified person has tested it and declared it or prepared it to be safe.</p>

ENGINE HAZARDS

	Fuel can cause fire or explosion..
	Engine fuel plus flames or sparks can cause fire or explosion. Do not weld near engine fuel. Do not spill fuel. If fuel is spilled, clean it up and do not start engine until fumes are gone.
	Do not smoke while fueling or if near fuel or fumes.
	STOP engine before fueling.
	DO NOT fuel a hot engine. Stop engine and let it cool off before checking or adding fuel.
	Engine exhaust gases can kill.
	Vent exhaust outside and away from any building air intakes.
	Use unit outside in open, well ventilated areas.
	Moving parts can cause injury. Keep hands, hair, loose clothing, and tools away from moving parts such as fans, belts, and rotors. Keep all doors, panels, and guards closed and secured.
	Battery explosion can blind. Sparks can cause battery gases to explode. Do not smoke and keep matches and flames away from battery. Wear a face shield or safety glasses when working near or on a battery.
	Battery acid can burn skin and eyes. Do not spill acid. Wear rubber gloves and a face shield or safety glasses when working on a battery.
	Steam and hot coolant can burn. Check coolant level when engine is cold to avoid scalding. If the engine is warm and checking is needed, wear safety glasses and gloves and put a rag over radiator cap. Turn cap slightly and let pressure escape slowly before completely removing cap.

	Exhaust sparks can cause fire. Use approved engine exhaust spark arrestor in required areas. Keep exhaust and exhaust pipes away from flammables. Do not locate unit near flammables.
	Hot parts can cause severe burns. Do not touch hot welder with bare hand. If handling is needed, use proper tools and/or wear heavy, insulated welding gloves to prevent burns. Allow cooling period before handling parts or working on gun or torch.

INSTALLATION AND ADVICE BEFORE USE

Use in open space, air swept or vent exhaust gases, which contain the deadly carbone oxyde, far from the work area.

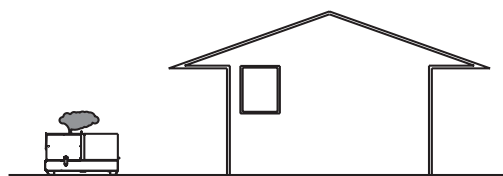
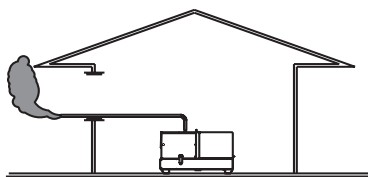
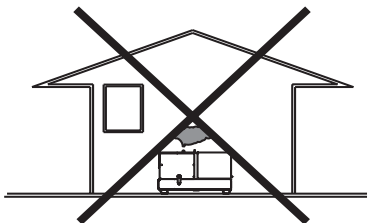

POSITION

Place the machine on a level surface at a distance of at least 1,5 m from buildings or other plants.

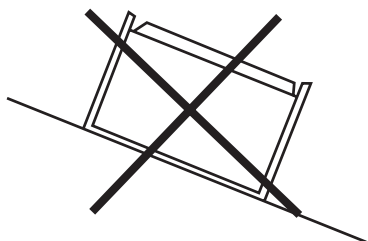

Check that the air gets changed completely and the hot air sent out does not come back inside the set so as to cause a dangerous increase of the temperature.

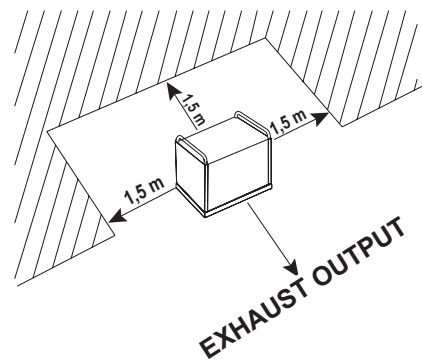

Make sure that the machine does not move during the work: **block** it possibly with tools and/or devices made to this purpose.

MOVES OF THE MACHINE

At any move check that the engine is **off**, that there are not connections with cables which impede the moves.

PLACE OF THE MACHINE AND/OR EQUIPMENTS



ATTENTION



For a safer use from the operator **DO NOT** fit the machine in locations with high risk of flood
Please do not use the machine in weather conditions which are beyond IP protection shown both in the data plate and on page named "technical data" in this same manual.

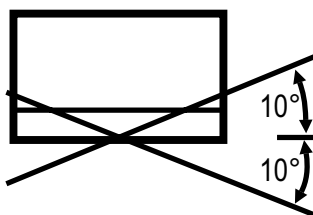

$\alpha = 20^\circ \text{ max}$

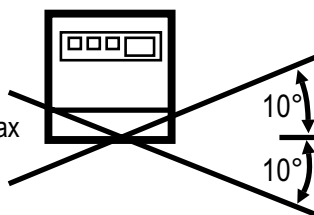

$\beta = 20^\circ \text{ max}$

Maximum leaning of the machine (in case of dislevel)

I INSTALLAZIONE E DIMENSIONI

D LUFTZIRKULATION UND ABMESSUNGEN

M

GB INSTALLATION AND DIMENSIONS

E INSTALACIÓN Y DIMENSIONES

2.7

F INSTALLATION ET DIMENSIONS

PT INSTALAÇÃO E DIMENSÕES

REV.2-01/16

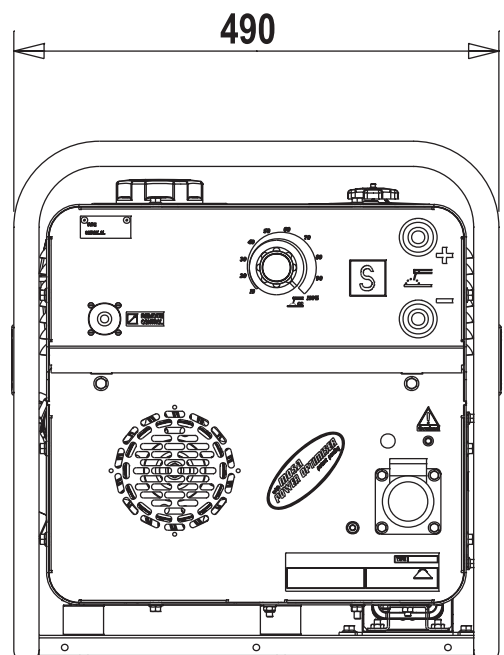
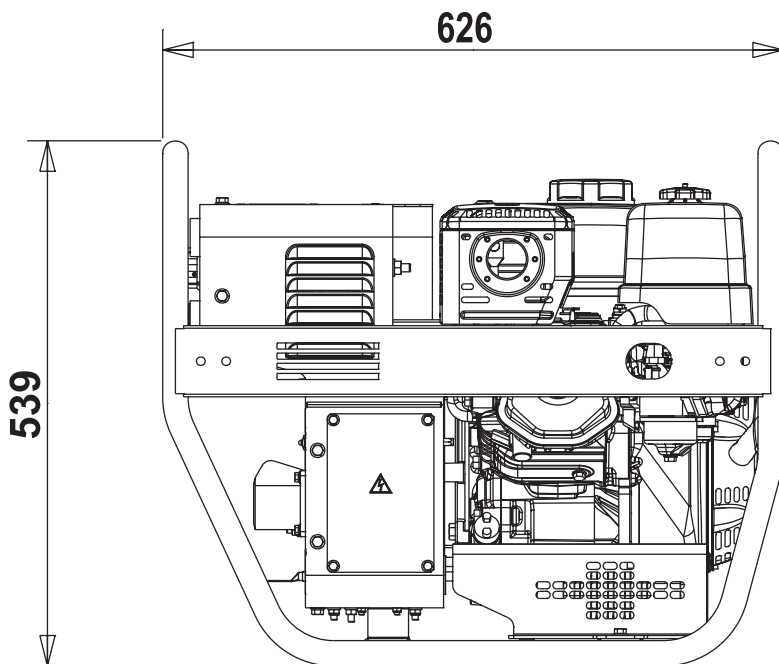
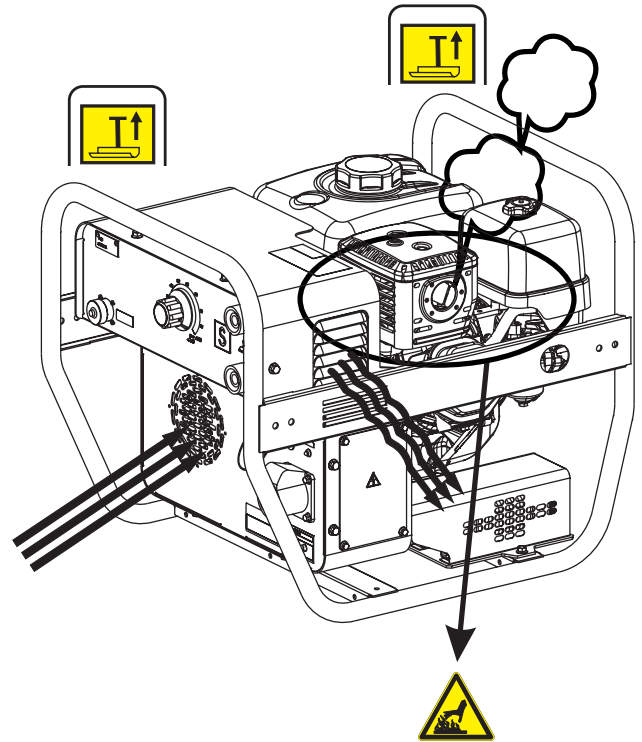
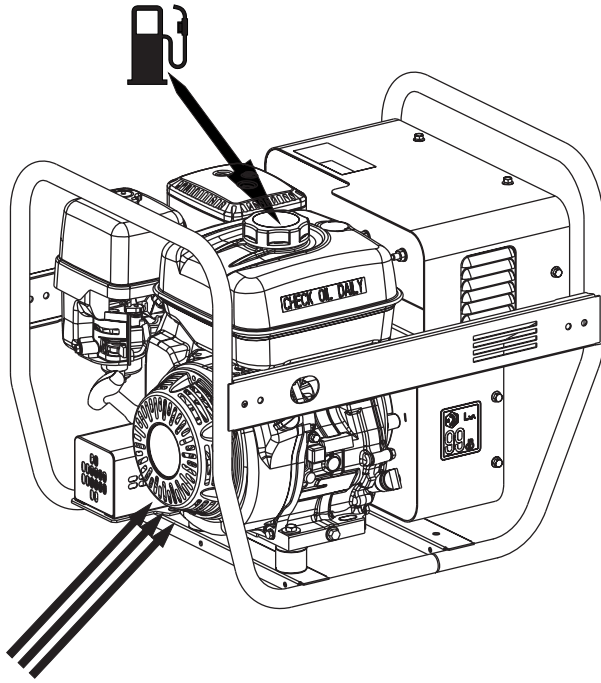



NOTE

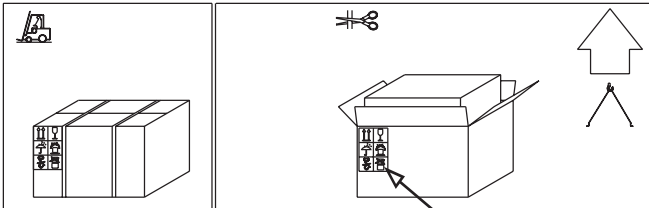
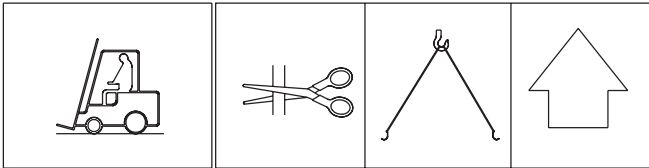

Be sure that the lifting devices are: correctly mounted, adequate for the weight of the machine with its packaging, and conforms to local rules and regulations. When receiving the goods make sure that the product has not suffered damage during the transport, that there has not been rough handling or taking away of parts contained inside the packing or in the set.

In case you find damages, rough handling or absence of parts (envelopes, manuals, etc.), we advise you to inform immediately our Technical Service.



For eliminating the packing materials, the User must keep to the norms in force in his country.

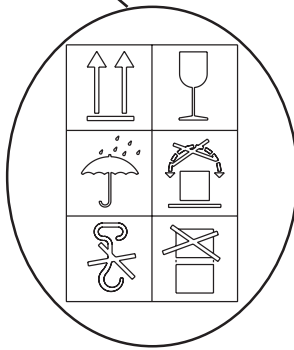

- 1) Take the machine (C) out of the shipment packing. Take out of the envelope (A) the user's manual (B).
- 2) Fit the handle as shown in the instructions (fitting: screws and spanner are supplied).
- 3) Read: the user's manual (B), the plates fixed on the machine, the data plate.

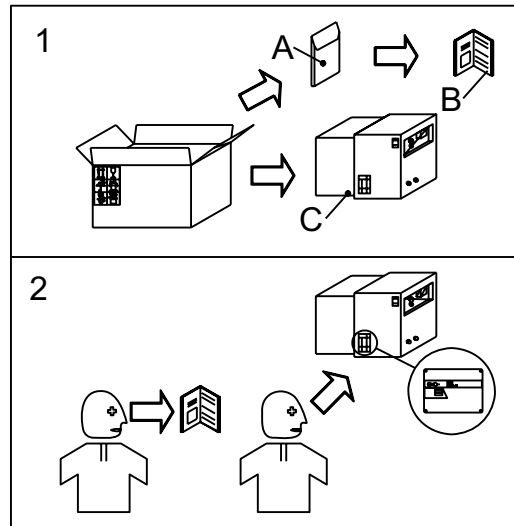

In case you should transport or move the machine, keep to the instructions as per the figures. Be sure that the lifting devices are: correctly mounted, adequate for the weight of the machine with its packaging, and conform to local rules and regulations. Only authorized persons involved in the transport of the machine should be in the area of movement.

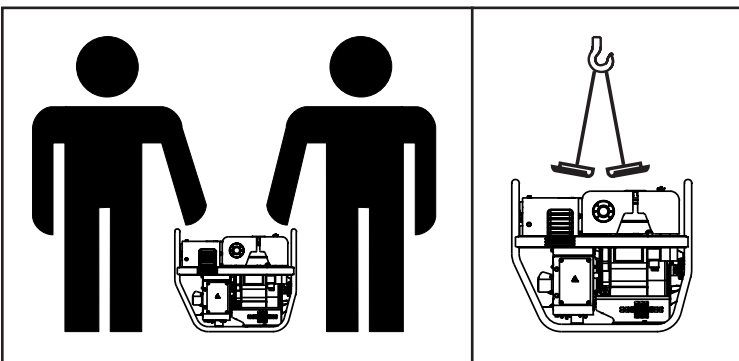

Note: Lift the machine and assemble the parts as shown in the drawing

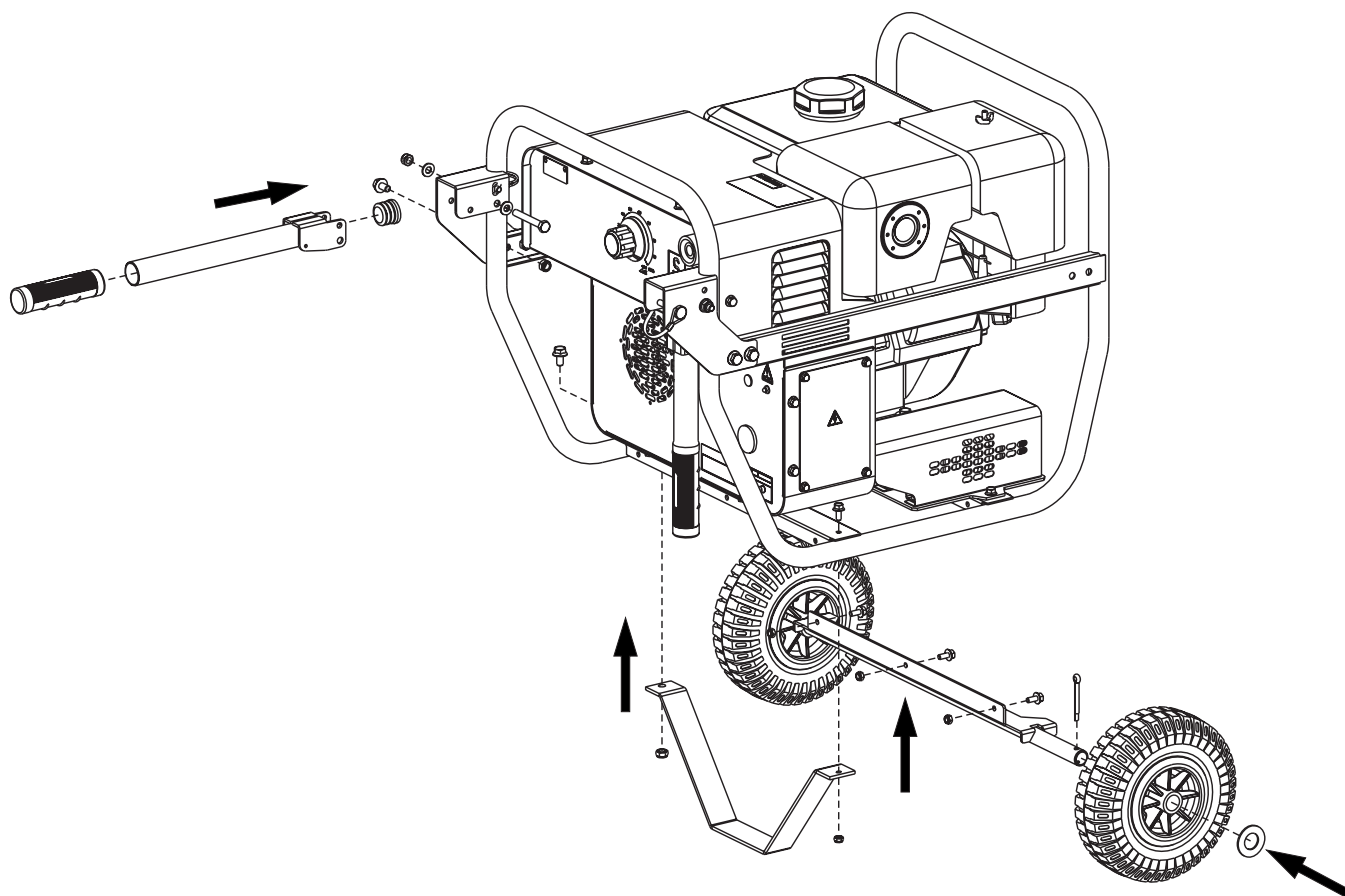

ATTENTION

The CTM accessory cannot be removed from the machine and used separately (actioned manually or following vehicles) for the transport of loads or anyway for used different from the machine movements.





LUBRICANT

Please refer to the motor operating manual for the recommended viscosity.

RECOMMENDED OIL

The manufacturer recommends selecting **AGIP** engine oil.

Refer to the label on the motor for the recommended products.

 PRODOTTI RACCOMANDATI RECOMMENDED PRODUCTS	
AGIP SIGMA TURBO PLUS 15W/40 API CG4 - ACEA E3	OLIO MOTORE DIESEL DIESEL ENGINE OIL
AGIP SUPERMOTOROIL 20W/50 API CC-SF	OLIO MOTORE BENZINA GASOLINE ENGINE OIL
AGIP ANTIFREEZE EXTRA INIBITE ETHYLENE GLYCOL (50% + 50% + H ₂ O)	CIRCUITO DI RAFFREDDAMENTO COOLING CIRCUIT (CUNA NC 956-16 ED 97)

To check the oil level:

1. Remove the oil-fill tap (24) and clean the dip-stick (23).
2. Insert the dip-stick into the oil filler without screwing it in.
3. If the oil level is low, fill with recommended oil up to the top of the oil filler

Oil fill tap / dip-stick

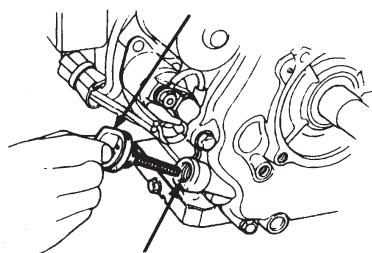

Upper oil level

MOTORS WITH OIL ALERT DEVICE

The "Oil Alert" system is designed to prevent damage to the motor due to an insufficient quantity of oil in the cup. This system automatically shuts off the motor before the oil level falls below the safety limit. If the motor does not start up again after shutting itself off, check the oil level.



FUEL



ATTENTION



Gasoline is highly flammable. Refuel with motor shut off in a flat surfaced well-ventilated area. Do not refuel in the presence of flames. Avoid spilling fuel.



Any eventual spilled fuel and fumes are flammable. Clean any dispersions of fuel before starting up the motor.



Fill the tank with gasoline for automobiles (preferably lead free or with low lead content in order to reduce deposits in the combustion chamber to a minimum).

For further details on the type of gasoline to use, see the motor operating manual supplied.

Do not fill the tank completely; leave a space of approx. 10 mm between the fuel level and the wall of the tank to allow for expansion.



AIR FILTER

Check that the dry air filter is correctly installed and that there are no leaks around the filter which could lead to infiltrations of non-filtered air to the inside of the motor.



WARNING

Do not use the machine if it is not in good technical condition

The machine must be in good working order before being used. Defects, especially those which regard the safety of the machine, must be repaired before using the machine.

Do not use without protective devices provided

Removing or disabling protective devices on the machine is prohibited.



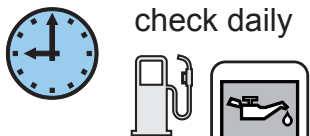

check daily

NOTE
Do not alter the primary conditions of regulation and do not touch the sealed parts.

Lightly pull the start-up knob (73) until meeting resistance, then pull decisively.

ATTENTION:

Allow the start-up knob to re-enter slowly, avoiding having it knock against the motor and thereby damaging the start-up system.

1. Turn the fuel cock (87) to ON.

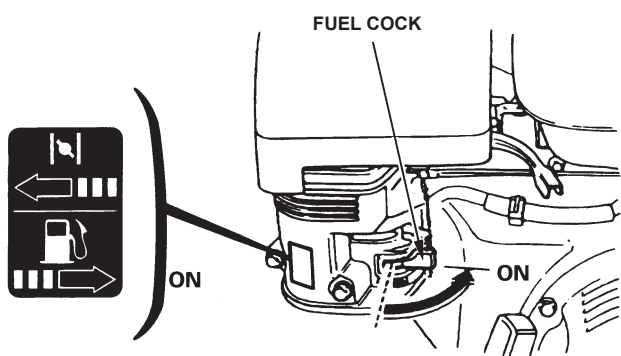

2. Switch the choke control (66) to CLOSE

N.B.: Do not use the air valve if the motor is hot or the air temperature is too high.

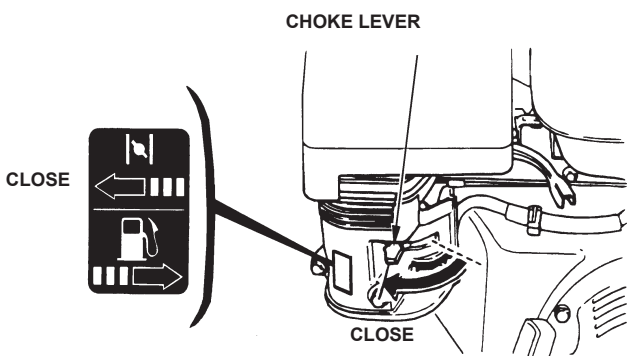

3. Turn the engine switch (28) to the ON position

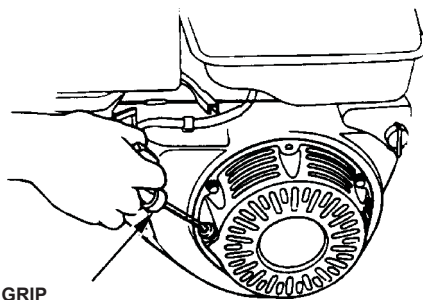
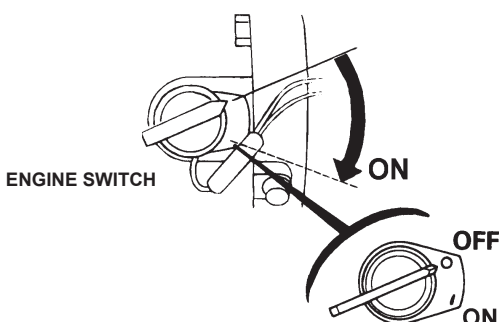

4. When the engine is started the machine reaches maximum engine speed immediately (4000 rpm) for 6/7 seconds, after which the engine speed automatically decreases to minimum (2000 rpm). The minimum is set by the solenoid which acts on the accelerator lever.

5. The engine reaches maximum speed only when current is drawn in welding or auxiliary power mode.

Before stopping the engine **it is compulsory:**

- Disconnect or close any power load connected to the system's auxiliary generation.
- Interrupt welding.



To shut down the motor:

For shut down the motor in case of emergency, turn the motor switch (28) to OFF.
In normal conditions, wait for the engine to reach minimum speed automatically 6/7 seconds after the load has been excluded. Turn the engine in these conditions for a few minutes so that it can cool down and then turn the engine switch (28) to OFF.

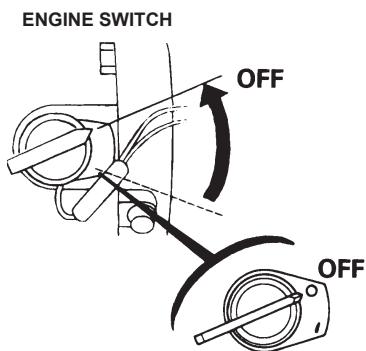

Turn the fuel valve to the OFF position.

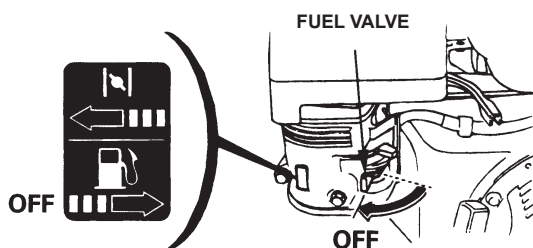

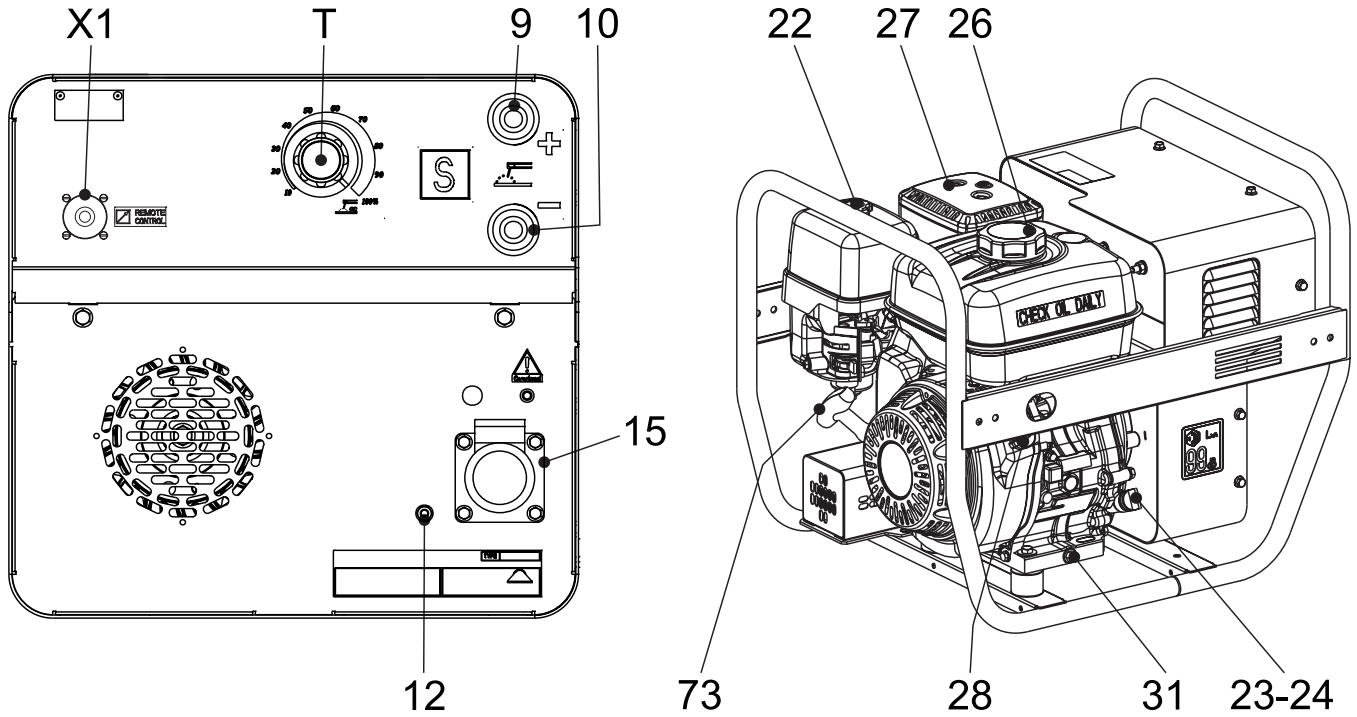

Pos.	Descrizione	Description	Description	Descripción
9	Prese di saldatura (+)	Welding sockets (+)	Prises de soudage (+)	Tomas de soldadura (+)
10	Prese di saldatura (-)	Welding sockets (-)	Prises de soudage (-)	Tomas de soldadura (-)
12	Presa di messa a terra	Earth terminal	Prise de mise à terre	Toma de puesta a tierra
15	Presa di corrente in c.c.	d.c. socket	Prises de courant en c.c.	Toma de corriente en c.c
22	Filtro aria motore	Engine air filter	Filtre air moteur	Filtro aire motor
23	Asta livello olio motore	Oil level dipstick	Jauge niveau huile moteur	Aguja nivel aceite motor
24	Tappo caricamento olio motore	Engine oil reservoir cap	Bouchon remplissage huile moteur	Tapón llenado aceite motor
26	Tappo serbatoio	Fuel tank cap	Bouchon réservoir	Tapón depósito
27	Silenziatore di scarico	Muffler	Silencieux d'échappement	Silenciador de descarga
28	Comando stop	Stop control	Commande stop	Mando stop
31	Tappo scarico olio motore	Oil drain tap	Bouchon décharge huile moteur	Tapón vaciado aceite motor
73	Comando manuale avviamento	Starting push button	Commande manuelle démarrage	Mando manual arranque
T	Regolatore corrente di saldatura	Welding current regulator	Régulateur courant soudage	Regulador corr. de soldadura
X1	Presa per comando a distanza	Remote control socket	Prise pour télécommande	Toma para mando a distancia



WARNING

Areas for which access by non-authorized personnel is **forbidden** are:

- the control panel (at the front) - the endothermic motor discharge.

CONNECT WELDING CABLES

Insert the welding cable plugs completely in the sockets, turning clockwise to lock them in place.

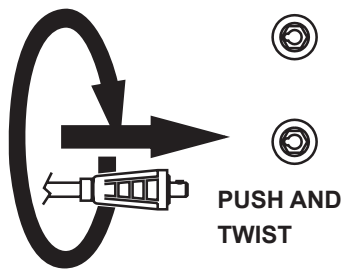

Connect the earth clamp to the negative pole and the electrode holder to the positive.

☞ Pay attention to the two polarities on the welding circuit, which must not come into electrical contact with each other.

- Carefully tighten the output cables to the bushings; if loose, they can cause problems of overheating and damage the bushings, cables, etc.
- Make certain the grounding pincer is connected as near as possible to the work station.

ADJUSTING THE WELDING CURRENT

The welding current is regulated by turning knob "T" continuously. If set to the minimum (turned fully in an anticlockwise direction) it provides a current of approximately 30 A; if set to the maximum (turned fully in a clockwise direction) it gives a maximum current of approximately 200A.

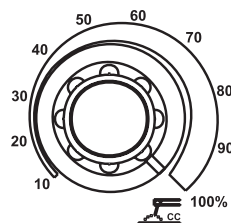

RECOMMENDED ELECTRODES

All the electrodes on the market can be used.



ATTENTION

To reduce the risk of electromagnetic interference, keep the welding cable length short and keep them on or near the ground. If possible, welding operations should not be done near sensitive electronic devices. If interference continues to occur, adopt additional measures: shift the group, use shielded cables, line filters, shield the entire work area.

If the above solutions do not suffice, consult our Technical Servicing Department.

AUTO IDLE

Operation

When the engine is switched on it immediately reaches a maximum speed of 3720 rpm for approximately 6/7 seconds for easy start up, after which it automatically decreases and idles at 2650 rpm. It remains at this speed until current is drawn when set to weld or auxiliary power. When set to weld mode the machine reaches maximum engine speed as soon as there is minimum contact between the tip of the electrode and the piece to be welded and also when set to generation drawing a minimum of 250 – 300 W. The machine returns to minimum 6/7 seconds later if power is not drawn during welding or generation.

Checking and adjusting idling speed

- Check idling speed when COLD;
- When the engine is switched on it reaches maximum speed; after 6/7 seconds it decreases automatically to idle. Check the speed when the engine idles;
- The idling speed corresponds to 47-50 Vdc at the welding sockets or the equivalent at 2650 rpm.

Minimum welding voltage TOO LOW

- From Fig. 1 proceed as follows:
 - when the machine idles (engine cold)
 - Keep pin A locked (8 mm spanner) and unscrew nut B (7 mm spanner)
 - Again with pin A locked, turn nut C clockwise (7 mm spanner) 1 - 3 mm: The more it is extended the more the idle speed increases
 - Tighten nut B on pin A and check the idling speed.

Minimum welding voltage TOO HIGH

- From Fig. 1 proceed as follows:
 - When the machine idles (engine cold)
 - Keep pin A locked (8 mm spanner) and unscrew nut B 1-3 mm (7 mm spanner)
 - Again with pin A locked, turn nut C anticlockwise (7 mm spanner) until nut B touches pin A
 - Tighten nut B against pin A and check that the idling speed is correct.

Adjusting the maximum engine speed

FIG. 1

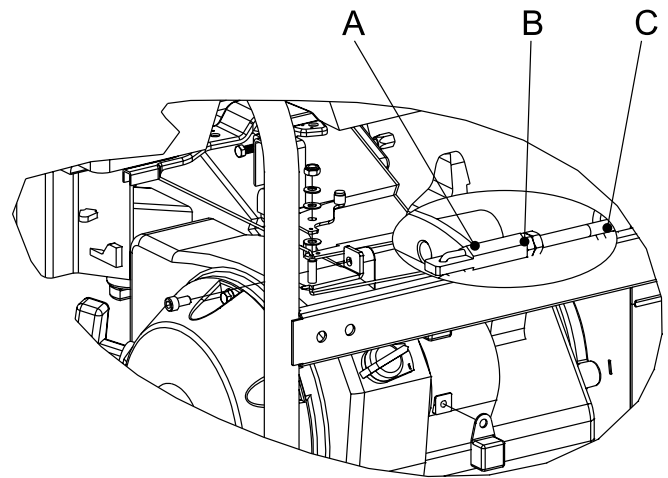

Calibration of maximum RPM (Revolutions Per Minute)

To check that the maximum engine RPM is correct, simply measure that the welding tension with no-load (not under load) at the maximum RPM must be between 69-71V.

Adjustment is made by the screw (A) Fig. 2.; first, however, the accelerator lever lock nut must be loosened, then carry out the adjustment, turning the screw (A) clockwise to reduce the maximum and anti-clockwise to increase it. Once the calibration has been carried out, re-tighten the accelerator lever lock nut.

FIG. 2

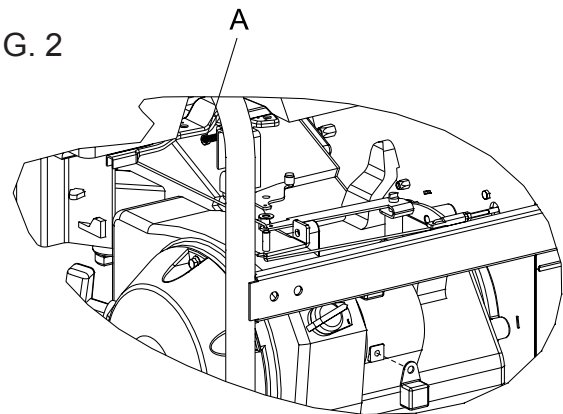

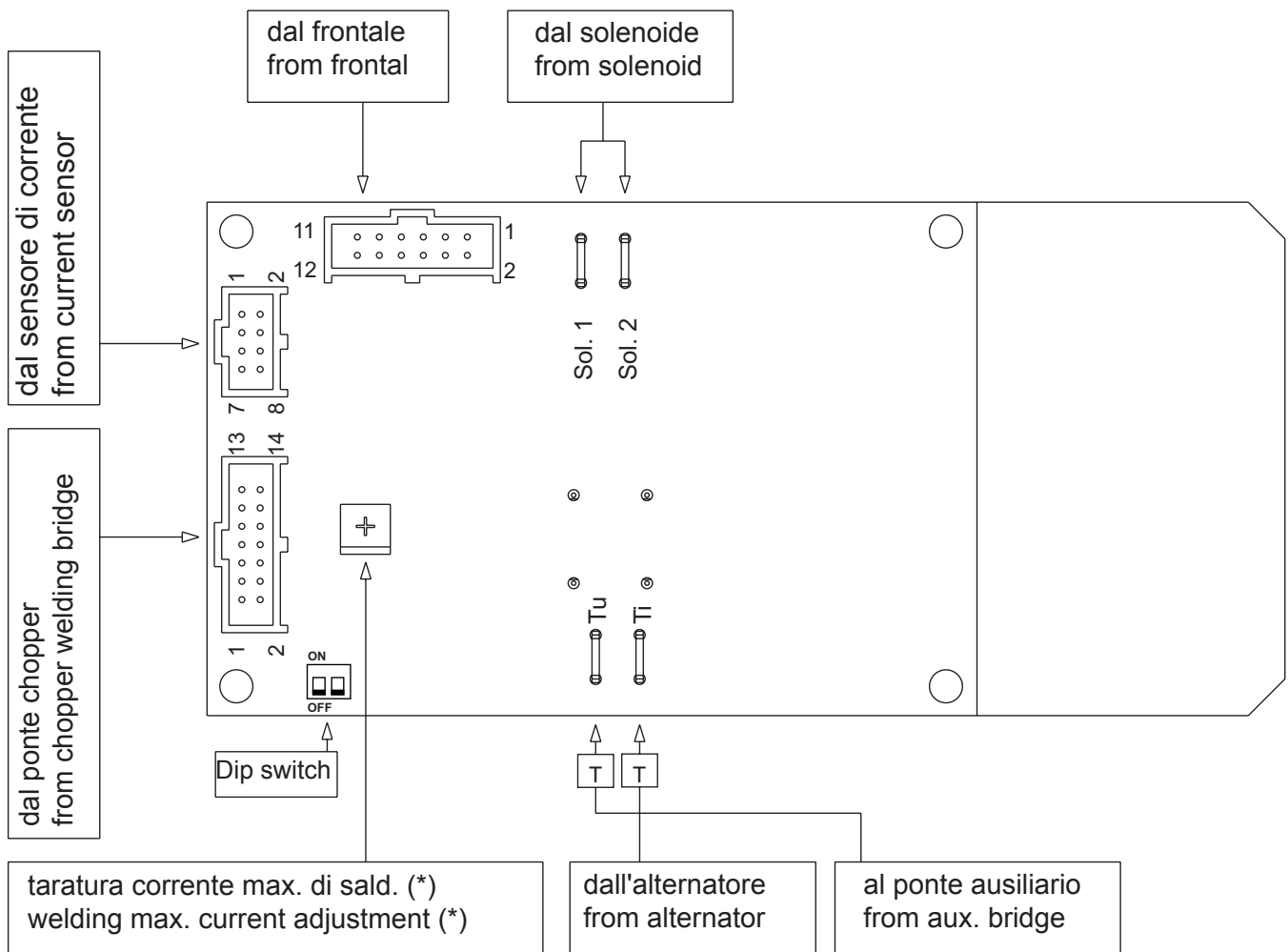

*) Tutte le volte che viene sostituita o la scheda o il sensore di corrente è necessario procedere ad una verifica della massima corrente di saldatura e eventualmente procedere ad una sua taratura nel seguente modo:

- Fissare la scheda sulla lamiera porta scheda, collegare tutti i cavi e connettori.
- Porre i Dip Switch secondo la figura. **Dip Switch**
- Ruotare il trimmer sulla scheda tutto in senso antiorario.
- Verificare che al minimo del potenziometro corrisponda il minimo della manopola.
- Porre la manopola di saldatura al minimo e avviare il motore. Lasciare che la macchina vada al minimo poi fare un corto circuito tra il + e - tramite i cavi di saldatura.
- Ruotare la manopola di saldatura al massimo.
- Ruotare lentamente il trimmer in senso orario affinché la corrente di saldatura arrivi a 200A.

*) Every time either the board or the current sensor is changed, it is necessary to check the max. welding current and, if it is the case, to set it as follows:

- Attach the pcb on its iron plate, connect all wires and all connectors.
- Put the dip-switch as drawing **Dip Switch**
- Rotate the trimmer on the board fully anticlockwise.
- Check that to the minimum of the potentiometer corresponds the minimum of the knob.
- Put the welding knob to the minimum and start the engine.
- Let the machine idle, then shortcircuit between the + and - welding sockets through the welding cables.
- Rotate the welding knob to the maximum.
- Slowly rotate the trimmer clockwise so that the welding current reaches 200 A.

How to put two machines in parallel:

from the front panels of the machines connect the two positives welding sockets(+) between themselves and the two negative welding sockets between themselves.
To effect the connection ask for the accessory K2X150.

ATTENTION: use fit cables and tight at the connection point.

How to proceed:

- start the machine putting the two welding handles (T) in the wanted position (half of the total current);
- put in parallel with the right cables;
- proceed with welding.

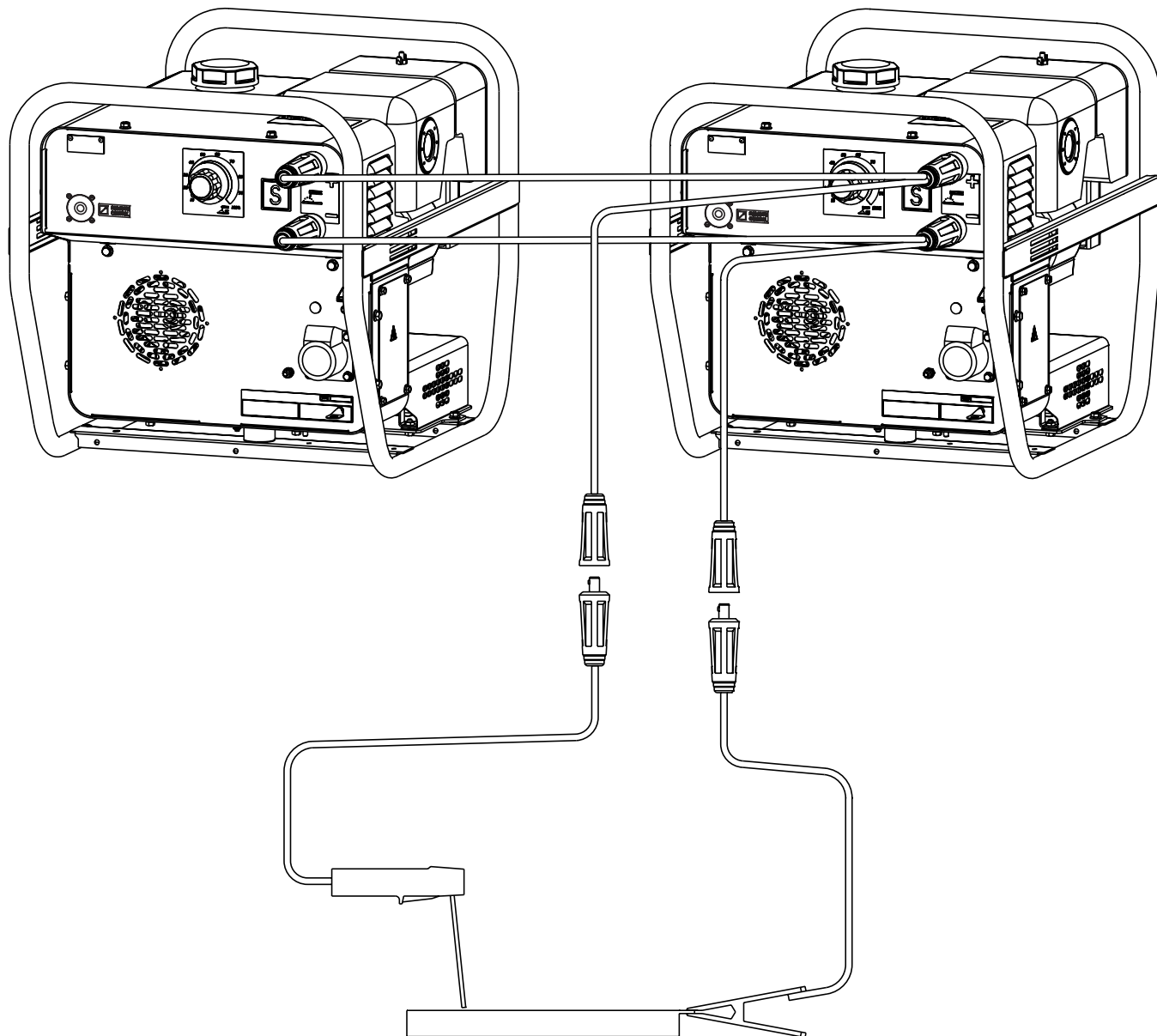



WARNING

It is absolutely forbidden to connect the unit to the public mains and/or another electrical power source.

Areas for which access by non-authorized personnel is **forbidden** are:
- the control panel (at the front) - the endo-thermic motor discharge.

AUXILIARY GENERATION IN AC 230V/50Hz

The auxiliary output is drawn by means of a 3 pole socket, the two poles are live, phase and neutral, plus the earth for the machine.

The single phase generation of the machine was designed to supply small power tools (grinders, drills etc.) to assist the welding operations with a quick, safe connection without the need to connect to earth. In addition, supplying only one tool at a time, the protection against indirect contact is assured by "electrical separation".

Therefore, the machine **MUST NOT** be intentionally connected to earth, attaching cables must be of 3 wires and the electrical equipment on which it being used must have an extension length limited to 100-200 metres. This limitation of circuit extension length is fundamental for safety.

The cables must be **SUITED** to the environment in which they are to be used. Bear in mind that at temperatures below 5°C PVC cables become rigid and the PVC insulation tends to split at the first crease.

Using double insulated equipment is advisable, this is identifiable by the symbol  and for having no earth facility.

If the machine is designed to supply circuits which are particularly complex or in an area with potential electrical risk, it is required to interpose a complete electrical distribution panel, equipped with all electrical protections required, between the plug and loads.

For example: you can use a distribution system TN-S. In this case one of the phases, used as a neutral must be grounded; a bipolar 30mA differential switch (GFI) must be mounted inside the electrical box, before the sockets to which loads are connected; the terminal in the frontal panel of the generating set near the socket is to be used as earth connection, wiring it to the ground of the electrical plant with which the machine is going to work.

WARNING: bound the neutral to frame **BEFORE** the GFI.



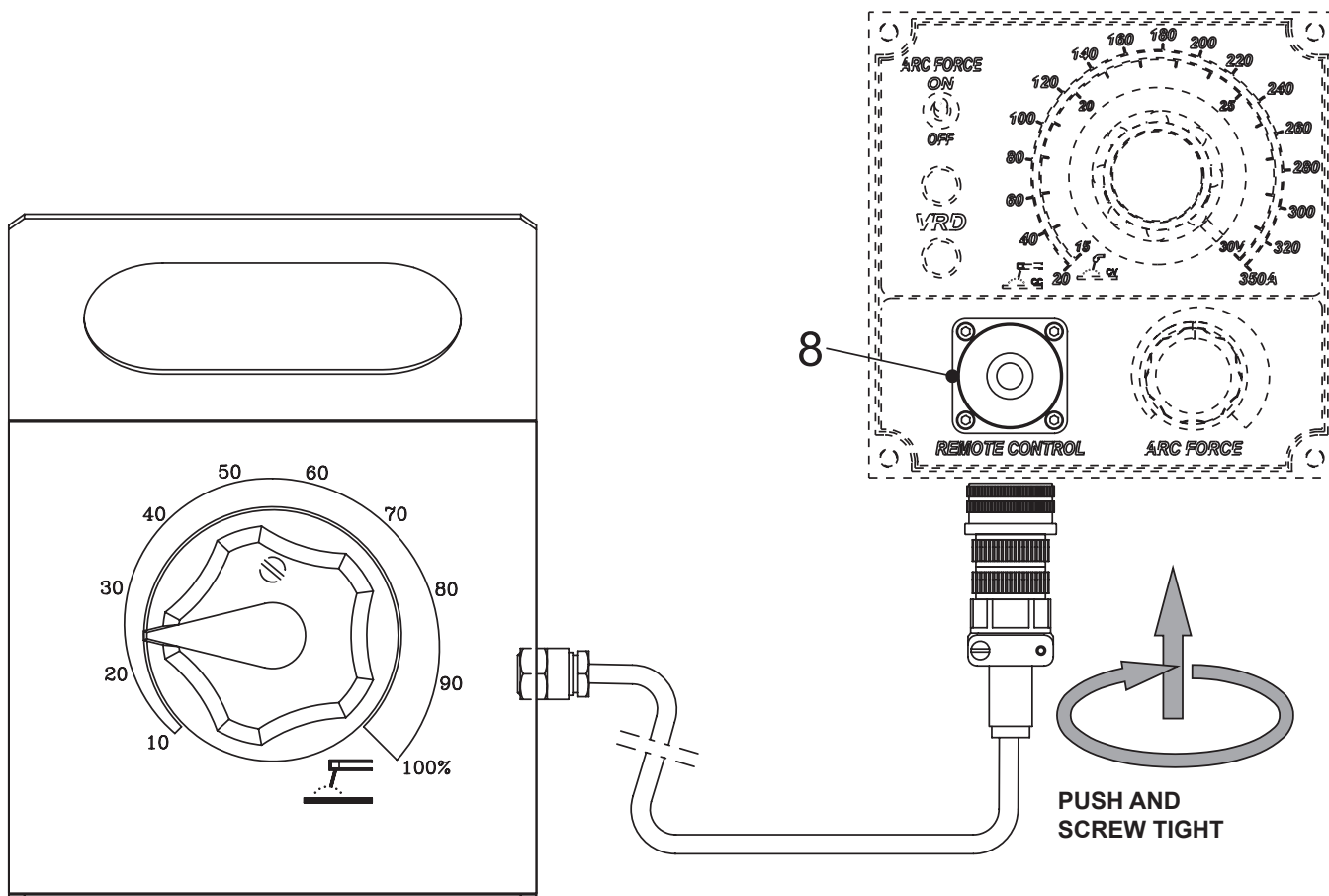

The remote control device for regulating the welding current is connected to the front panel by means of a multipole connector.

When the remote control is connected to the remote control connector (8), it is functional and automatically excludes the front panel regulation.



Position welding current adjusting (T) knob at the necessary current value for the diameter and type of electrode.

Problem	Possible cause	Solution
The motor does not start up, or starts up and then stops immediately	1) Engine switch (28) at position OFF 2) Lack of or insufficient oil in the motor 3) Faulty motor stopping device (oil-alert) 4) Lack of fuel in tank or fuel tap closed 5) Dirty or faulty spark plug 6) Cold motor 7) Other causes	1) Position switch to ON 2) Refill or top off 3) Replace 4) Refill the tank. Open the fuel tap 5) Clean or check and eventually replace 6) Hold down the CHOKE button, after start-up, for a longer period of time 7) Consult the motor Operating Manual.
No current under no-load conditions in weld mode	1) Chopper welding bridge broken 2) Faulty circuit 3) Faulty alternator	1) Use a multimeter to test that there are 3 Kohms between pins 1-2; if NOT replace the bridge 2) Replace 3) Disconnect the welding and auxiliary power cables. Use a voltmeter to check that there is 48 Vac at the outputs in weld and approximately 145 Vac between the outputs in generation. Carry out the check when the engine idles (disconnect one of the two wires to the solenoid)
No current under no-load conditions in auxiliary power mode	1) Fuse open 2) Auxiliary power diode bridge broken 3) Faulty circuit 4) Faulty alternator	1) replace the fuse 10A retarded for version 230V 15A retarded for version 110V 2) Use a multimeter to check the 2 single phase diode bridges on the auxiliary power 3) Replace 4) Disconnect the welding and auxiliary power cables. Use a voltmeter to check that there is 48 Vac at the outputs in weld and approximately 145 Vac between the outputs in generation. Carry out the check when the engine idles (disconnect one of the two wires to the solenoid).
Incorrect minimum voltage under no-load conditions	1) Incorrect solenoid adjustment	1) Adjust the solenoid as shown on page M34.

Problem	Possible cause	Solution
Incorrect maximum voltage under no-load conditions	1) Incorrect maximum engine speed	1) Adjust the maximum engine speed as shown on page M34.
Engine always at idle speed	1) Faulty circuit	1) Replace
Engine always at maximum speed	1) faulty circuit 2) Faulty solenoid	1) Replace; 2) Check that the resistance of the solenoid winding is approximately 10 ohm.
Insufficient power during welding or generation	1) Engine	1) Dirty petrol filter, dirty air filter, dirty carburetor. See engine instruction booklet.
Irregular or inconsistent welding current	1) alternator windings not insulated from earth 2) welding chopper bridge not insulated from earth 3) power cables not insulated from earth 4) faulty circuit	1) Disconnect all the outputs; 3 for welding which go to the chopper bridge and 4 for auxiliary power which go to the circuit board. Use a multimeter to check the insulation of the alternator; 2) disconnect the 3 welding cables, the + and - for welding, the black wire and the connector which go to the circuit board, Use a multimeter to check that the bridge is insulated from the earth. 3) check that the cables inside the aluminium casting, are properly insulated; 4) Replace

RESISTENCE OF WINDING 110V/230V

OUTPUT	Ω (ohm)	NOTE
Output in weld mode Between green / black cable Between green / red cable Between black / red cable	0,011 0,011 0,011	
Auxiliary power outputs Between the black cables	0,300	Value measured alternating the cables
Auxiliary power outputs Between the brown cables	0,300	Value measured alternating the cables

 WARNING		
	<ul style="list-style-type: none"> • Have qualified personnel do maintenance and troubleshooting work. • Stop the engine before doing any work inside the machine. If for any reason the machine must be operated while working inside, pay attention moving parts, hot parts (exhaust manifold and muffler, etc.) electrical parts which may be unprotected when the machine is open. • Remove guards only when necessary to perform maintenance, and replace them when the maintenance requiring their removal is complete. • Please wear the appropriate clothing and make use of the PPE (Personal Protective Equipment), according to the type of intervention (protective gloves, insulated gloves, glasses). • Do not modify the components if not authorized. - See pag. M1.1 - 	
MOVING PARTS can injure		HOT surface can hurt you



MAINTENANCE OF THE MACHINE

Maintenance refers to all operations regarding the control and replacement of mechanical and electrical parts subject to wear. In addition it refers to the control and topping up or replacement of fluids such as fuel, oil and the regular cleaning of the machine.

Repairs refers to the substitution of worn or damaged parts and repairs should be carried out by Authorized Service Centres.

Refer to the Engine Manufacturer's Manual for the maintenance instructions for the engine. Periodic maintenance should be performed according to the schedule shown in this manual.

On a regular basis check that there are no obstructions in the aspiration/exhaust ducts of the alternator, the engine or the housing which could restrict the flow of cooling air.

 IMPORTANT
<div style="display: flex; align-items: center;">  <p>In the maintenance operations avoid that polluting substances, liquids, exhausted oils, etc. bring damage to people or things or can cause negative effects to surroundings, health or safety respecting completely the laws and/or dispositions in force in the place.</p> </div>

DRY AIR FILTER

Replace the air filter cartridge every 200 hours under normal conditions and every 100 hours in dusty environments.

PERMANENT MAGNET ALTERNATOR

No maintenance is necessary, as the alternator has no brushes or slip rings, and there are no devices for regulation of the output.

WARNING LABELS AND DECALS

Check warning labels and decals once a year and **replaced** if missing or unreadable.

CABLES AND CONNECTIONS

Periodically check the condition of the cables and tighten the connections.

 IMPORTANT
When carrying out maintenance operations be careful to avoid polluting the environment with the materials used during maintenance. Follow all local health and safety regulations.

☞ Have **qualified** personnel prepare the machine for the cust-off.

STORAGE

In case the machine will not be used for more than 30 days, it should be stored in a suitable area where it is protected from the elements to prevent rusting, corrosion and other damage to the machine.

ENGINE

Run the engine until it stops from lack of fuel.

For long periods of storage, refer to the engine manufacturer's manual.

Clean the machine carefully.

Cover the machine with a plastic cover and store in a dry place.

In case of necessity for first aid and fire prevention, see page M2.



IMPORTANT



In the storage or cust-off operations avoid that polluting substances, liquids, exhausted oils, etc. bring damage to people or things or can cause negative effects to surroundings, health or safety respecting completely the laws and/or dispositions in force in the place.

CUST-OFF

As cust off we intend all operations to be made, at utilizer's care, at the end of the use of the machine.

This comprises the dismantling of the machine, the subdivision of the several components for a further reutilization or for getting rid of them, the eventual packing and transportation of the eliminated parts up to their delivery to the store, or to the bureau encharged to the cust off or to the storage office, etc.

The several operations concerning the cust off, involve the manipulation of fluids potentially dangerous such as: lubricating oil.

The dismantling of metallic parts liable to cause injuries or wounds, must be made wearing heavy gloves and using suitable tools.

The getting rid of the various components of the machine must be made accordingly to rules in force of law a/o local rules.

Particular attention must be paid when getting rid of: lubricating oils, inflammable liquids such as fuel.

The machine user is responsible for the observance of the norms concerning the environment conditions with regard to the elimination of the machine being cust off and of all its components.

In case the machine should be cust off without any previous disassembly it is however compulsory to remove:

- tank fuel
- engine lubricating oil

NOTE: The manufacturer is involved with custing off the machine **only** for the second hand ones, when not reparable. This, of course, after authorization.



The information here below are to be intended only as indicative since the above norm is much larger. For further details please see the specific norms and/or the manufacturers of the product to be used in the welding process.

RUTILE ELECTRODES: E 6013

Easily removable fluid slag, suitable for welding in all position. Rutile electrodes weld in d.c. with both polarities (electrode holder at + or -) and in a.c.. Suitable for soft steels R-38/45 kg/mm². Also for soft steels of lower quality.

BASIC ELECTRODES: E 7015

Basic electrodes weld only in d.c. with inverse polarity (+ on the electrode holder) ; there are also types for a.c. Suitable for impure carbon steels. Weld in all position.

HIGH YIELD BASIC ELECTRODES: E 7018

The iron contained in the coating increases the quality of metal added. Good mechanical properties. Weld in all position. Electrode holder at + (inverse polarity). Weld deposit of nice aspect, also vertical. Workable; high yield. Suitable for steels with high contents of sulphur (impurities).

CELLULOSIC ELECTRODES: E 6010

Cellulosic electrodes weld only in d.c. with polarity + electrode holder - ground clamp. Special for steels run on pipes with R max 55 kg/mm². Weld in all position. volatile slag.

ELECTRODES IDENTIFICATION ACCORDING TO A.W.S. STANDARDS

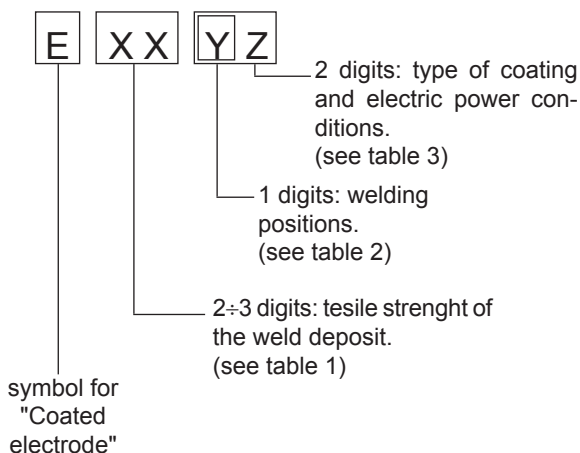

Number	Strength	
	K.s.l.	Kg/mm ²
60	60.000	42
70	70.000	49
80	80.000	56
90	90.000	63
100	100.000	70
110	110.000	77
120	120.000	84

Table 1

1	for all positions
2	for plane and vertical
3	for plane position only

Table 2

N°	Descrizione
10	Cellulose electrodes for d.c.
11	Cellulose electrodes for a.c.
12	Rutile electrode for d.c.
13	Rutile electrode for a.c.
14	High yield rutile electrodes
15	Basic electrodes for d.c.
16	Basic electrodes for a.c.
18	High yield basic electrodes for d.c. (inverse polarity)
20	Acid electrodes for flat or front position welding for d.c. (- pole) and for a.c.
24	High yield rutile electrodes for flat or front plane position welding for d.c. and a.c.
27	High yield acid electrodes for flat or front plane position welding for d.c. (- pole) and a.c..
28	High yield basic electrodes for flat or front plane position welding for d.c. (inverse polarity)
30	Extra high yield acid electrodes, extra high penetration if required, for flat position welding only for d.c. (- pole) and a.c.

Table 3

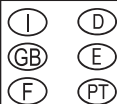

Legenda schema elettrico

A : Alternatore
H : Presa 230V monofase
I : Presa 110V monofase
R : Unità controllo saldatura
T : Regolatore corrente saldatura
Y : Ponte diodi saldatura
Z : Prese di saldatura
W : Reattore c.c.
F1 : Elettromagnete acceleratore
S2 : Trasmettitore livello olio
F3 : Pulsante stop
G3 : Bobina accensione
H3 : Candela accensione
W6 : Sensore di hall
R8 : Inverter
S8 : Led Overload
Z8 : Scheda comando a distanza

Electrical system legende

A : Alternator
H : 230V 1phase socket
I : 110V 1-phase socket
R : Welding control PCB
T : Weldin current regulator
Y : Welding diode bridge
Z : Welding sockets
W : D.C. inductor
F1 : Acceleration solenoid
S2 : Oil level transmitter
F3 : Stop push-button
G3 : Ignition coil
H3 : Spark plug
W6 : Hall sensor
R8 : Inverter
S8 : Overload led
Z8 : Remote control PCB

Legende des schemas electriques

A : Alternateur
H : Prise 230V monophasé
I : Prise 110V monophasé
R : Unite contrôle soudage
T : Régulateur courant soudage
Y : Pont diodes soudage
Z : Prises de soudage
W : Réactance c.c.
F1 : Electro-aimant accélérateur
S2 : Transmetteur niveau huile
F3 : Bouton stop
G3 : Bobine allumage
H3 : Bougie allumage
W6 : Senseur de hall
R8 : Inverseur
S8 : Voyant Surcharge
Z8 : Télécommande fiche

Stromlaufplan-Referenzliste

A : Generator
H : Steckdose 230V 1-phasig
I : Steckdose 110V 1-phasig
R : Steuerplatine Schweißstrom
T : Schweißstromregler
Y : Diodenbrücke Schweißstrom
Z : Schweißbuchsen
W : DC-Drossel
F1 : Elektromagnet Motordrehzahl
S2 : Ölstandssensor
F3 : Taste Stopp
G3 : Zündspule
H3 : Zündkerze
W6 : Hall-Sensor
R8 : Inverter
S8 : Led Überbelastung
Z8 : Fernbedienungsplatine

Leyenda esquema eléctrico

A : Alternador
H : Toma 230V monofásica
I : Toma 110V monofásica
R : Unidad control soldadura
T : Regulador corriente soldadura
Y : Puente diodos soldadura
Z : Tomas de soldadura
W : Reactor c.c.
F1 : Electromagnetismo acelerador
S2 : Captador nivel aceite
F3 : Pulsador stop
G3 : Bobina encendido
H3 : Bujía encendido
W6 : Sensor de entrada
R8 : Inverter
S8 : Led Overload
Z8 : Mando a distancia tarjeta

Legenda esquema elétrico

A : Alternador
H : Tomada 230V monofásica
I : Tomada 110V monofásica
R : Unidade controlo soldadura
T : Regulador corrente soldadura
Y : Ponte díodos soldadura
Z : Tomada de soldadura
W : Reactor c.c.
F1 : Electromagnetismo acelerador
S2 : Captador nivel de óleo
F3 : Botão stop
G3 : Bobina de partidda
H3 : Vela de partida
W6 : Sensor de hall
R8 : Inversor
S8 : Luz Overload
Z8 : Tomada de comando à distância

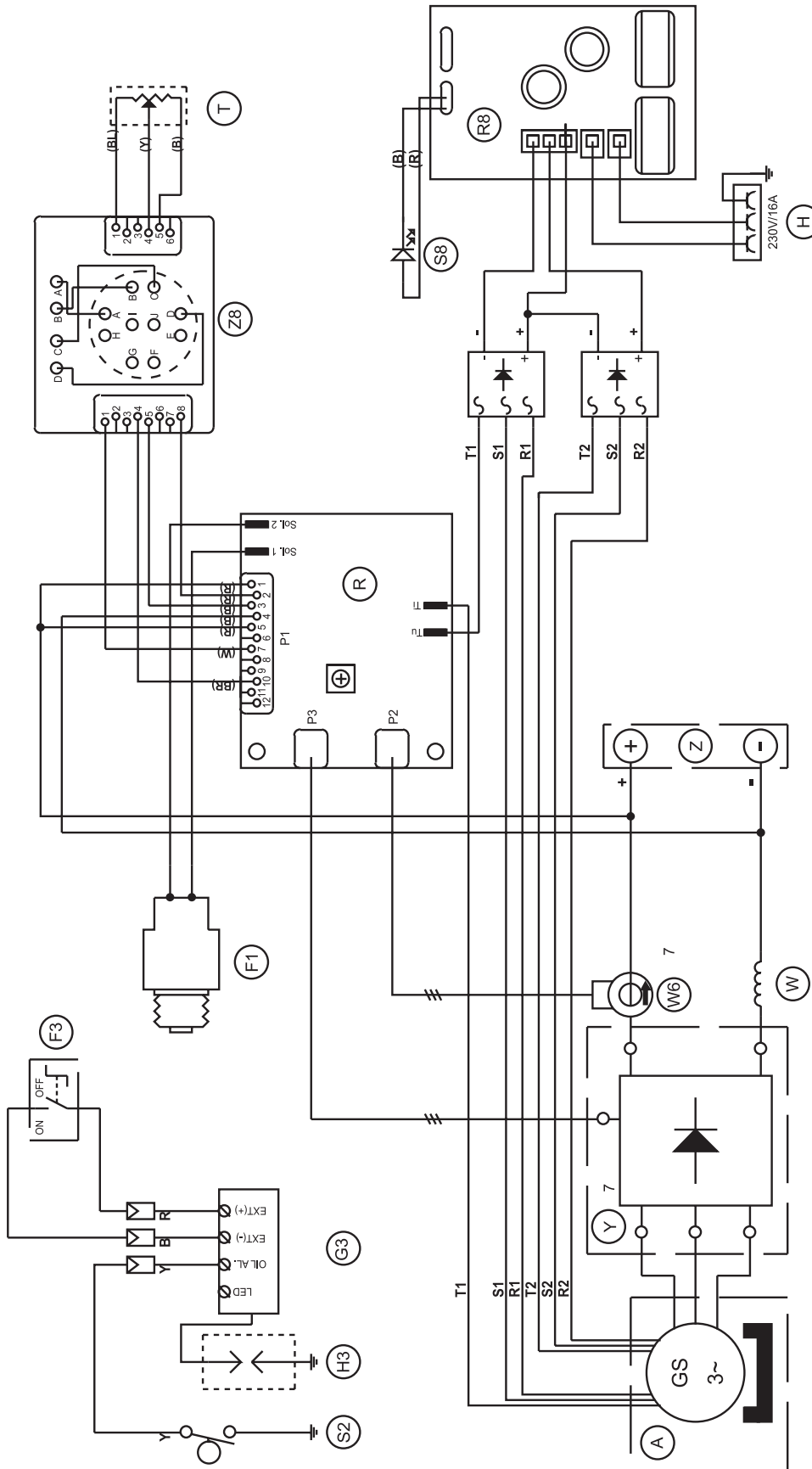

E	Modificato collegamento dell' Inverter (R8) per migliorarne il funzionamento.	07.10.2015	B.F.
D	Corretto collegamento Ponti diodi - Inverter (R8) come da cablaggio.	06.12.2012	B.F.
C	Sostituito motore HONDA GX270 UT1 (VXB7) con nuovo GX270 UT2 (VXB7).	07.07.2011	B.F.
B	Sostituita unità controllo saldatura (R).	08.03.2011	B.F.
A	Aggiunto scheda comando a distanza (Z8).	15.06.2009	N.L.
Exp.	Modifica	Data	Dis. Appr.
Exp.	Denominazione:	Projecto:	Proj. n.º
	From Page	Project:	Page n.º of n.º
	To Page	Project:	Page n.º of n.º
Wiring Diagram		22250.prg	2
Disegnatore:		Data:	Dis. n.º
Designer:		Date:	Dwg. n.º
Leporace N.		06.11.2008	22250.S.060-E

LEGENDA COLORI	KEY COLOR
(B)	NERO/BLACK
(R)	ROSSO/RED
(Y)	GIALLO/YELLOW
(BL)	BLU/BLUE
(W)	BIANCO/WHITE
(BR)	MARRONE/BROWN



MOSA

MOSA div. della BCS S.p.A.

Viale Europa, 59 20090 Cusago (Milano) Italy

Tel. +39 - 0290352.1 Fax +39 - 0290390466 www.mosa.it

